



01911E00





**Light Fittings for
Fluorescent Lamps
Series EXLUX 6000 (Zone 1)
Series EXLUX 6400
(Zones 2, 21 & 22)**

- As pendant or pole-mounting fittings
- With electronic ballast
- For two-pin fluorescent lamps
- 1 or 2 lamp versions: 18 W, 36 W and 58 W
- Central locking
- All-pole disconnection via N/C switch when cover is opened
- Enclosure in polyester resin
- Cover in polycarbonate
- End of Life switching-off (only 6000)

Series **EXLUX 6000** and **EXLUX 6400** light fittings can be used for normal lighting, and also as group- or centrally-supplied emergency lights.

Zones 1 & 2, 21 & 22

Light Fittings for Fluorescent Lamps Series EXLUX 6000 (Zone 1) Series EXLUX 6400 (Zones 2, 21 & 22)

Selection table					
Version	Lamp wattage W	Number of lamps	Electronic ballast	Ordering code	Weight kg
Standard light fittings (Zone 1) Series 6000  <small>01968E00</small>	18	1	1 channel ECG	6000/521-8..1-013.	4,500
		2	2 channel ECG	6000/522-9..1-013.	6,800
	36	1	1 channel ECG	6000/541-8..1-013.	7,300
		2	2 channel ECG	6000/542-9..1-013.	9,100
	58	1	1 channel ECG	6000/561-8..1-013.	10,200
		2	2 channel ECG	6000/562-9..1-013.	10,800
Pole-mounting light fitting (Zone 1) Series 6000  <small>01962E00</small>	18	1	1 channel ECG	6000/821-8081-013.	6,700
		2	2 channel ECG	6000/822-9081-013.	6,800
	36	1	1 channel ECG	6000/841-8081-013.	9,500
		2	2 channel ECG	6000/842-9081-013.	9,600
Standard light fittings (Zones 2, 21 & 22) Series 6400  <small>01968E00</small>	18	1	1 channel ECG	6400/521-8..0-213.	4,100
		2	2 channel ECG	6400/522-9..0-213.	4,200
	36	1	1 channel ECG	6400/541-8..0-213.	6,900
		2	2 channel ECG	6400/542-9..0-213.	7,000
	58	1	1 channel ECG	6400/561-8..0-213.	8,700
		2	2 channel ECG	6400/562-9..0-213.	8,800
Pole-mounting light fitting (Zones 2, 21 & 22) Series 6400  <small>01962E00</small>	18	1	1 channel ECG	6400/821-8080-213.	6,300
		2	2 channel ECG	6400/822-9080-213.	1,000
	36	1	1 channel ECG	6400/841-8080-213.	9,100
		2	2 channel ECG	6400/842-9080-213.	9,200
Add. to ordering code					
Through wiring	without			6.00/...-0...-...	
	with 3 cores			6.00/...-3...-...	
	with 5 cores			6.00/...-5...-...	
Cable entries	Standard	1 x M 25 x 1.5 cable gland and 2 x M 25 x 1.5 stopping plugs		6.00/...-1...-...	
	Special	Specify non-standard entries on writing		6.00/...-9...-...	
Monitoring module	without			6.00/...-...-...0	
	6048/110-02 Adressbaustein (STAHL)			6.00/...-...-...2	
Note The light fittings are supplied without tubes and mounting material. These must be ordered separately.					



Light Fittings for Fluorescent Lamps

Series EXLUX 6000 (Zone 1)

Series EXLUX 6400 (Zones 2, 21 & 22)

Technical Data			
Version	EXLUX 6000 (Zone 1)	EXLUX 6400 (Zones 2, 21 & 22)	
Explosion protection			
Gas explosion protection	⊕ II 2 G EEx ed IIC T4	⊕ II 3 G EEx nA II T4	
Dust explosion protection	⊕ II 2 D IP 65 T80 °C ... T90 °C	Zone 21: ⊕ II 2 D IP 66 T80 °C ¹⁾ Zone 22: ⊕ II 3 D IP 66 T80 °C ¹⁾ ¹⁾ T80 °C at T _a ≤ 40 °C; T95 °C at T _a ≤ 55 °C	
Certificates			
Gas explosion protection	PTB 97 ATEX 2031	Zone 2: SNCH 03 ATEX 3517	
Dust explosion protection	PTB 97 ATEX 2031	Zone 21: SNCH 03 ATEX 3516 Zone 22: SNCH 03 ATEX 3517	
Other certificates	IECEX, LOSC (Australia), VNIIEF (Russia), FM (USA), CSA (Canada), UL do Brasil (Brasil)	FM (USA), CSA (Canada)	
Marking	CE 0102		
Rated voltage	AC: 220 V - 10% ... 240 V + 10%; 50/60 Hz DC: 198 V ... 254 V		
Rated current	for light fittings version		for light fittings version
	18 W	36 W	58 W
	18 W	36 W	58 W
1 lamp	0,1 A	0,18 A	0,25 A
2 lamps	0,18 A	0,33 A	0,49 A
Power factor cos φ	cos φ ≥ 0.97 capacitive; additional compensation not required		
Ambient temperature	- 20 °C ... + 50 °C		
Lamps	two-pin fluorescent lamps; ∅ 26 mm; socket G13, according to IEC 60081		
	Standard light fitting:	1 x 18 W	2 x 18 W
		1 x 36 W	2 x 36 W
		1 x 58 W	2 x 58 W
	Pole-mounting light fitting:	1 x 18 W	2 x 18 W
		1 x 36 W	2 x 36 W
End of Life -Abschaltung	The ballast may also be manufactured with a modified electronic circuitry.		--
	The electronic ballast, type 6042/9... meets the requirements according to IEC 61347-2-3 (simulation of the „end-of-life-effect“ or fluorescent lamps, test 1: „asymmetrical-pulse-test“ and test 2: „asymmetrical-power-test“ corresponding to the test conditions stated in the draft of IEC 60079-7 ed.4, annex H).		
Protection	IP 66 / IP 67 IP 64 when using breathing gland 8162		
Protection class	I (with internal PE connection terminal)		
Efficiency of light	broad bowl		
	18 W / 36 W / 58 W	1 lamp	83 %
		2 lamps	76 %
Material			
Enclosure	Polyester resin, glass fibre reinforced		
Gasket	Polyurethane gasket, foamed into cover		
Cover	Polycarbonate		
Central lock	Central locking using socket spanner M 8 / SW 13; cover hinged for access		
Light guides	Standard: broad bowl, reflector of light fitting is white cover side is anti-glare		
	Special: additional broad deep-bowl reflector (easily mounted) semi-polished aluminium		

Light Fittings for Fluorescent Lamps

Series EXLUX 6000 (Zone 1)

Series EXLUX 6400 (Zones 2, 21 & 22)



Technical Data					
Connections	<p>Standard: Terminal block with cover Marking: L1 + N + PE (3 pole) or L1 + L2 + L3 + N + PE (5 pole) Connection range: max. 2 x 6 mm² (solid); 2 x 4 mm² (flexible)</p> <p>Special: Spring-clamp-terminal; Connection range: max. 2 x 2.5 mm²</p>				
Version	<table border="0" style="width: 100%;"> <tr> <td style="width: 50%; vertical-align: top;"> <p>EXLUX 6000 (Zone 1)</p> <p>of light fitting on opening power to ballast is disconnected; switching element with 2 NC contacts in positive opening operation</p> <p>of faulty lamps if lamp is faulty, power supply is automatically switched off by the electronic ballast</p> </td> <td style="width: 50%; vertical-align: top;"> <p>EXLUX 6400 (Zones 2, 21 & 22)</p> <p>of faulty lamps if lamp is faulty, power supply is automatically switched off by the electronic ballast</p> </td> </tr> </table>	<p>EXLUX 6000 (Zone 1)</p> <p>of light fitting on opening power to ballast is disconnected; switching element with 2 NC contacts in positive opening operation</p> <p>of faulty lamps if lamp is faulty, power supply is automatically switched off by the electronic ballast</p>	<p>EXLUX 6400 (Zones 2, 21 & 22)</p> <p>of faulty lamps if lamp is faulty, power supply is automatically switched off by the electronic ballast</p>		
<p>EXLUX 6000 (Zone 1)</p> <p>of light fitting on opening power to ballast is disconnected; switching element with 2 NC contacts in positive opening operation</p> <p>of faulty lamps if lamp is faulty, power supply is automatically switched off by the electronic ballast</p>	<p>EXLUX 6400 (Zones 2, 21 & 22)</p> <p>of faulty lamps if lamp is faulty, power supply is automatically switched off by the electronic ballast</p>				
Switch-off					
Cable glands	<p>Standard light fitting</p> <table border="0" style="width: 100%;"> <tr> <td style="width: 15%;">Standard</td> <td>1 x M 25 x 1.5 cable gland 8161 and 2 x M 25 x 1.5 plugs 8290</td> </tr> <tr> <td>Special</td> <td>1 x M 20 x 1.5 cable gland 8161 and 2 x M 20 x 1.5 plugs 8290</td> </tr> </table> <p style="margin-left: 40px;">metal glands: M 20, M 25; earthing via metal adapter plates</p> <p>Pole-mounting light fitting</p> <p>with factory mounted pole mounting sleeve: 1 x M 32 x 1.5 cable gland 8161</p>	Standard	1 x M 25 x 1.5 cable gland 8161 and 2 x M 25 x 1.5 plugs 8290	Special	1 x M 20 x 1.5 cable gland 8161 and 2 x M 20 x 1.5 plugs 8290
Standard	1 x M 25 x 1.5 cable gland 8161 and 2 x M 25 x 1.5 plugs 8290				
Special	1 x M 20 x 1.5 cable gland 8161 and 2 x M 20 x 1.5 plugs 8290				
Monitoring module					
Function	<p>Monitoring and switch module for central battery systems in accordance to VDE 0108: The module is capable of performing the single monitoring of light fitting and the combined circuit of normal and emergency light fittings. The module offers the following functionality:</p> <ul style="list-style-type: none"> • Control of the light fitting (ON / OFF) and function testing • Within one circuit it is possible to operate up to 20 modules via a coding switch • Each single device within a circuit can be programmed as: permanent light, stand-by light and switched light • Mixed operation of modules in one circuit possible 				
Input voltage	<p>(Input between L+ and N-)</p> <table border="0" style="width: 100%;"> <tr> <td style="width: 10%;">U_N</td> <td>230 VAC (+10%/-15%); 50 Hz</td> </tr> <tr> <td>U_{DC}</td> <td>175 V ... 275 VDC</td> </tr> </table>	U _N	230 VAC (+10%/-15%); 50 Hz	U _{DC}	175 V ... 275 VDC
U _N	230 VAC (+10%/-15%); 50 Hz				
U _{DC}	175 V ... 275 VDC				
Control input	<p>(between L and N)</p> <table border="0" style="width: 100%;"> <tr> <td style="width: 10%;">U_N</td> <td>230 VAC (+10%/-15%); 50 Hz</td> </tr> </table>	U _N	230 VAC (+10%/-15%); 50 Hz		
U _N	230 VAC (+10%/-15%); 50 Hz				
Connection power (Output)	P 4 W ... 100 W				
Ambient temperature limit	t _{a (Modul)} - 10 °C ... + 50 °C				
Dimensions	L x B x H = 95 mm x 40 mm x 32 mm				
Through wiring	<table border="0" style="width: 100%;"> <tr> <td style="width: 30%;">Looping through of cable</td> <td> <p>Standard fitting There are 2 M 25 x 1.5 cable entries on the connection side for looping through of connection cable (entry and exit on one side), also possible with lights subsequently fitted with pole sleeve.</p> </td> </tr> <tr> <td>Through wiring</td> <td> <p>Standard fitting Fittings can be supplied with internal through-wiring. Entry and exit holes for connection cables are positioned on opposite sides. A through-wiring kit can be fitted after manufacture (see accessories). For terminal details see technical data. Wiring cross-section 2.5 mm² for max. 16 A.</p> </td> </tr> </table>	Looping through of cable	<p>Standard fitting There are 2 M 25 x 1.5 cable entries on the connection side for looping through of connection cable (entry and exit on one side), also possible with lights subsequently fitted with pole sleeve.</p>	Through wiring	<p>Standard fitting Fittings can be supplied with internal through-wiring. Entry and exit holes for connection cables are positioned on opposite sides. A through-wiring kit can be fitted after manufacture (see accessories). For terminal details see technical data. Wiring cross-section 2.5 mm² for max. 16 A.</p>
Looping through of cable	<p>Standard fitting There are 2 M 25 x 1.5 cable entries on the connection side for looping through of connection cable (entry and exit on one side), also possible with lights subsequently fitted with pole sleeve.</p>				
Through wiring	<p>Standard fitting Fittings can be supplied with internal through-wiring. Entry and exit holes for connection cables are positioned on opposite sides. A through-wiring kit can be fitted after manufacture (see accessories). For terminal details see technical data. Wiring cross-section 2.5 mm² for max. 16 A.</p>				

Light Fittings for Fluorescent Lamps



Series EXLUX 6000 (Zone 1)

Series EXLUX 6400 (Zones 2, 21 & 22)

Technical Data

Mounting	for outdoor installation a breather gland is recommended
	<p>Pendant light fitting</p> <p>Standard: 2 x M 8 inserts in enclosure</p> <p>Special: Mounting grooves in housing to accommodate bracket fitting and ceiling rails for variable light installation. (variable mounting distance for fittings 18 W: 312 mm ... 465 mm; 36 W / 58 W: 670 mm ... 865 mm)</p> <p>A pole-mounting sleeve can also be fitted to the standard light fitting</p> <p>Pole mounting fitting</p> <p>On sleeve dia 42 mm secured by a clamp. Pole-mounting sleeve normally fitted at the factory but can be retro fitted, entry as for standard fitting.</p> <p>Entry of cable:</p> <p>factory-mounted pole sleeve: Cable is brought into fitting through sleeve. Cable entry is sealed by a gland M 32 x 1.5.</p> <p>pole sleeve is retro fitted: Entry as for standard fitting</p>

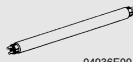
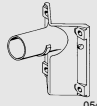
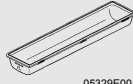
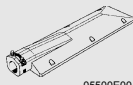



Accessories and spare parts

Designation	Illustration	Description	Ordering code	Weight kg
Fluorescent lamps	 04936E00	Two pin base \varnothing 26 mm Light colour: Universal white		
		18 W 1100 lm	4617220	0,100
		36 W 2600 lm	4617210	0,200
		58 W 4100 lm	4617200	0,283
Wall-mounting bracket	 05460E00	for pole-mounting fitting; with conduit 400 mm long, \varnothing 42 mm	4617170	2,480
Plastic cover	 05329E00	for light fitting 18 W	6000815050	0,800
		for light fitting 36 W	6000816050	1,500
		for light fitting 58 W	6000817050	1,800
Pole-mounting sleeve	 05500E00	for retro-fitting to lights 18 W and 36 W, complete with mounting accessories	6000801750	2,100
Switch	 05651E00	Switch element 8080/1-3-L, 2 NC	8080006600	0,025



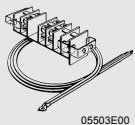
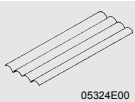

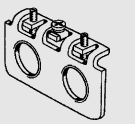
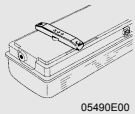
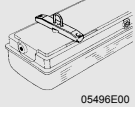
Light Fittings for Fluorescent Lamps Series EXLUX 6000 (Zone 1) Series EXLUX 6400 (Zones 2, 21 & 22)

7

STAHL

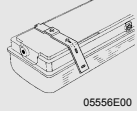
Accessories and spare parts					
Designation	Illustration	Description	Ordering code	Weight kg	
Mounting kit for through wiring	 05503E00	for retro-fitting to light fittings 18 W and 36 W DV 5 with 5 core, 2.5 mm ² for max. 16 A; L1, L2, L3, N, PE			
		for light fitting 18 W	6000812870	0,400	
		for light fitting 36 W	6000814870	0,400	
		for light fitting 58 W	6000816870	0,400	
		DV3; screw terminals 3 x 2.5 mm ² , max. 16 A L1 + N + PE			
		for light fitting 18 W	6000811870	0,200	
		for light fitting 36 W	6000813870	0,250	
		for light fitting 58 W	6000815870	0,215	
Reflectors	 05324E00	for retro-fitting; broad-deep-bowl			
		for 1 lamp light fittings 18 W	6000801580	0,128	
		for 1 lamp light fittings 36 W	6000803580	0,264	
		for 1 lamp light fittings 58 W	6000805580	0,334	
		for 2 lamp light fittings 18 W	6000802580	0,126	
		for 2 lamp light fittings 36 W	6000804580	0,272	
		for 2 lamp light fittings 58 W	6000806580	0,396	
Socket spanner	 05321E00	M 8 / SW 13; to operate central locking	8198005400	0,126	
Adapter plates	 05755E00	for use with metal cable glands which are integrated into the earthing system via the stainless steel adapter plates			
		1 x M 20 x 1.5	1 pc	6000815550	0,070
		1 x M 25 x 1.5	1 pc	6000816550	0,070
		1 x NPT 1/2"	1 pc	6000817550	0,070
		1 x NPT 3/4"	1 pc	6000818550	0,070
		2 x M 20 x 1.5	1 pc	6000819550	0,060
		2 x M 25 x 1.5	1 pc	6000820550	0,060
		2 x NPT 1/2"	1 pc	6000821550	0,060
Mounting rail	 05490E00	for variable mounting distance	1 pair	6000802750	0,326
Mounting clamp	 05496E00	Clamp mounted to mounting rail for variable mounting distance	1 pair	6000807750	0,426
Ring bolts	 05378E00	M 8, to mount directly into inserts, 1 pair		6000803900	0,107

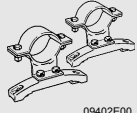
Light Fittings for Fluorescent Lamps Series EXLUX 6000 (Zone 1) Series EXLUX 6400 (Zones 2, 21 & 22)

Accessories and spare parts				
Designation	Illustration	Description	Ordering code	Weight kg
Wall-mounting bracket 90°		Material: stainless steel, 1 pair	6000802440	1,500
Wall-mounting bracket 50°		Material: stainless steel, 1 pair	6000801440	1,000
Ceiling clip bracket		for ceiling mounting of light fitting 1 pair	6000803750	0,280
Pipe clamp		With mounting rail for variable fitting distance Material: stainless steel 1 pair		
		R 1 1/2"	6000801260	1,200
		R 2"	6000802260	1,200
		R 1 1/4	6000803260	1,274
Breathing gland		for ventilating and draining M 25 x 1.5	6000803960	0,010

Dimension drawings (all dimensions in mm) - subject to alterations

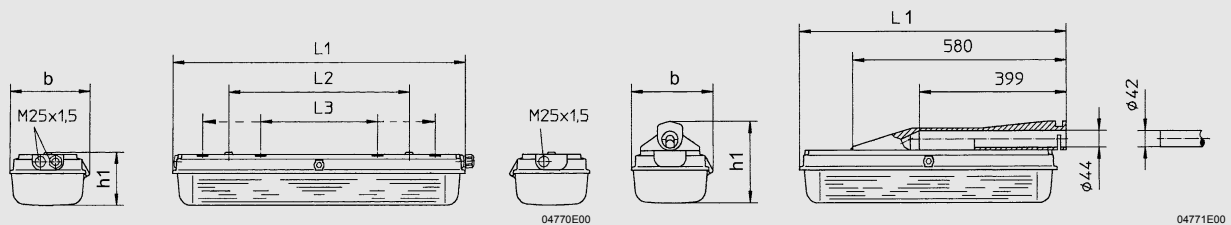

Dimensions in mm	Light fitting		
	18 W	36 W	58 W
L1	700	1310	1610
L2 ¹⁾	400	800	800
L3 ²⁾	312 ... 465	670 ... 865	670 ... 865
b	221	221	221
h1	143	143	143

¹⁾ fixed mounting distance
²⁾ variable mounting distance

Dimensions in mm	Light fitting	
	18 W	36 W
L1	724	1334
b	221	221
h1	213	213

EXLUX 6000 and EXLUX 6400 Standard light fitting

EXLUX 6000 and EXLUX 6400 Pole-mounting light fitting

Dimension drawings for Accessories and spare parts (all dimensions in mm) - subject to alterations

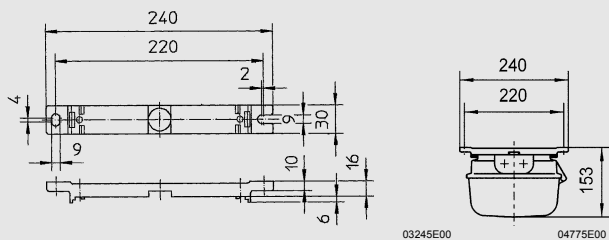

Ceiling bracket

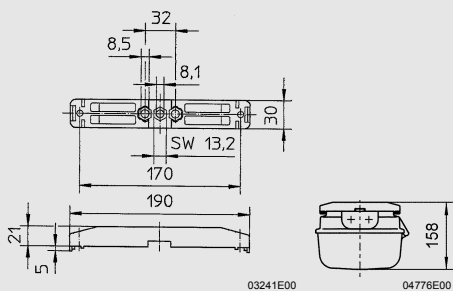

Mounting bracket

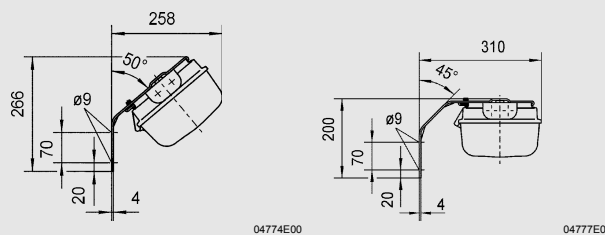

Wall-mounting bracket 50°

Wall-mounting bracket 90°

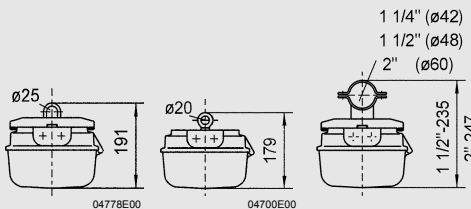

Mounting clamp fitted in mounting rail

Ring bolt M8 fitted into inserts

Pipe clamp fitted in mounting rail

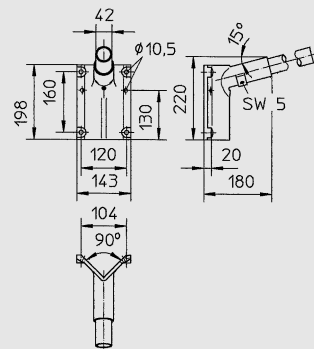

Wall-mounting bracket with conduit

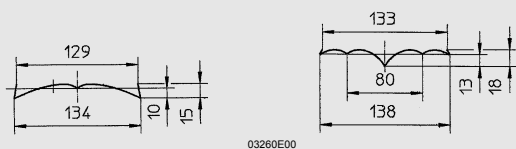

for 1 lamp light fitting

for 2 lamp light fitting

Reflector for fitting	Length in mm
18 W	554
36 W	1164
58 W	1464

Reflectors

We reserve the right to make alterations to the technical data, weights, dimensions, designs and products available without notice. The illustrations cannot be considered binding.

