



01831E00

Indicating Lamp Series 8010

- Explosion protection to
 - CENELEC
 - IEC
- For use in Zone 1 and Zone 2
- Low heat build-up
- Very long life
- Maintenance-free
- Available in:
 - red, yellow, green, blue, white
- Available forms
 - Ex e
 - Ex i





STAHL

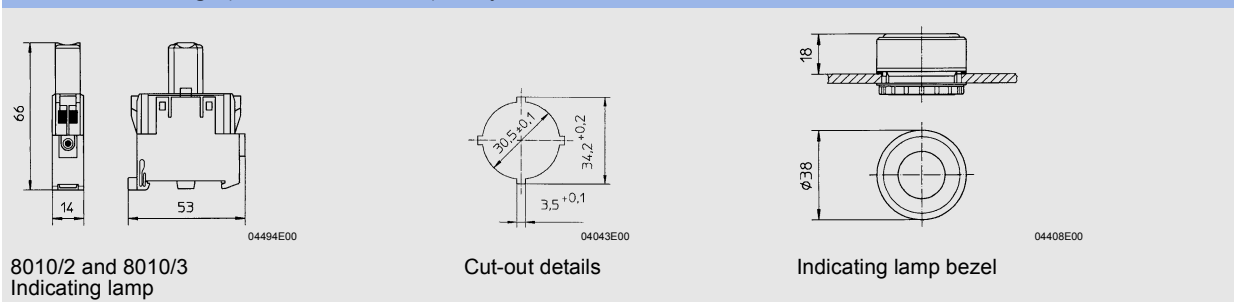

Indicating lamps Series 8010 are based on the use of LED's. The indicating lamp displays the current state of a command by either switching on or switching off a light signal. In combination with a switchgear device, they indicate the switching state. Indicating lamps Series 8010 are designed to be built into an enclosure of the protection type „Increased Safety“. The light signal is displayed from the enclosure via the transparent lamp insert cover equipped with a diffuser lens. This making it easy to detect a light signal under bad light conditions.

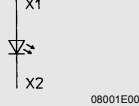
Dimension drawings (all dimensions in mm) - subject to alterations

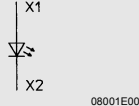

Zones 1 & 2

Selection table					
Version	Description	Schematic	Colour	Ordering code	Weight kg
 01393E00 Diode Indicating Lamp 8010/2 Ex e	Rated voltage: 12 V ... 254 V Voltage toleranz: - 10 % ... + 6 %	 08001E00	white	8010/2-01-ws	0,035
 01825E00 Diode Indicating Lamp 8010/3 Ex i	Voltage: 10,8 V ... 28 V Safety data Ex i: $U_i \leq 28 \text{ V}$ $I_i \leq 150 \text{ mA}$ $P_i = 1 \text{ W}$	 08001E00	white	8010/3-02-ws	0,032
 01394E00 Calotte 8602 A with colour filter			red	8602A0054-1-rt	0,024
			yellow	8602A0054-1-ge	0,024
			green	8602A0054-1-gn	0,024
			blue	8602A0054-1-bl	0,024
			white	8602A0054-1-ws	0,024

Technical Data	
Explosion protection	Ex e:  II 2 G EEx de IIC Ex i:  II 2 G EEx d ia/ib IIC
Certificates	PTB 01 ATEX 1160 U
Other certificates	IECEX, CSA (Canada), UL (USA), SIMTARS (Australia)
Rated Voltage	Ex e: 12 V - 10 % ... 254 V + 6 %, AC / DC Ex i: 10,8 V ... 28 V
Safety data Ex i	$U_i \leq 28 \text{ V}$ $I_i \leq 150 \text{ mA}$ $P_i = 1 \text{ W}$
Frequency range	0 Hz ... 60 Hz
Rated current	max. 15 mA
Rated output	max. 1 W
Electrical life	10^5 output hours
Ambient temperature	- 40 °C ... + 55 °C
Colours	red, yellow, green, blue, white
Light source	Luminescent diode / white
Luminance	1200 cd/m ²
Housing	Polyamide
Terminals	2,5 mm ² , flexible
Calotte	
Material	Polyamide
Version	round, \varnothing 38 mm; calotte: clear; colour filter: red, yellow, green, blue, white; lens with diffusing element for optimum visibility
Impact strength	$\geq 7 \text{ Nm}$
Degree of protection	IP 66



We reserve the right to make alterations to the technical data, weights, dimensions, designs and products available without notice. The illustrations cannot be considered binding.