



01715E00

Illuminated Pushbutton for Panel Mounting Series 8018

- Explosion protection to
 - CENELEC
 - IEC
- For use in
 - Zone 1 and Zone 2
 - Zone 21 and Zone 22
- In spring-return versions
- With flexible lead 6 m
- Colours:
 - red, yellow, green, blue, white
- 2 contact elements
 - NC / NO
 - NC / NC
 - NO / NO
- Colour filtering
via coloured insert caps

STAHL

The illuminated pushbutton Series 8018 combines switching and signalling functions. One button allows switching of load, control and signal circuits while simultaneously indicating their actual operating state by means of a LED diode which lights up or dims. It consists of a main assembly with 2 flameproof encapsulated contacts, an indicating lamp unit equipped with LED as its light source as well as a panel-mounting bezel and button actuator. The illuminated pushbutton Series 8018 is an explosion protected electrical apparatus. It is suited for installation on switching control room walls and electrical device covers as well as in electrical cabinet panels or control desks. The illuminated pushbutton Series 8018 is designed for D 30 single hole installation as per EN 50 007 and in combination with actuator attachment Series 8602.

Zones 1 & 2, 21 & 22

Selection Table

Version	Description	Order number	Weight kg
 8018 Illuminated pushbutton	with flexible lead 6 m length		
	contact assembly 1 NC + 1 NO	8018/3113-al-6	0,740
	contact assembly 2 NC	8018/3123-al-6	0,740
	contact assembly 2 NO	8018/3133-al-6	0,740
Note		The coloured insert lens red, yellow, green, blue, white added in packing Gold-contacts on request	

Technical Data

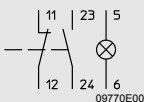
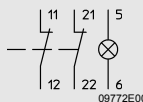
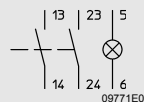

Explosion protection			
Gas explosion protection	⊕ II 2 G Ex d mb IIC T6		
Dust explosion protection	⊕ II 2 D tD A21 IP65 T80 °C		
Certificates	PTB 02 ATEX 2129 X		
Other certificates	CSA (Canada)		
Ambient temperature	- 30 °C ... + 60 °C		
Rated working voltage			
Contact element	max. 270 V		
Indicating lamp unit	12 V - 10 % ... 254 V + 6 % AC / DC		
Rated working current			
Contact element	max. 6 A		
Indicating lamp unit	0.014 A at 24 V DC		
Frequency	0 Hz ... 60 Hz		
Rated output	max. 0.6 W		
Schematic	 8018/3113	 8018/3123	 8018/3133
Light source	white LED colour red, yellow, green, blue or white via colour filter		
Min. voltage*	12 V AC / DC		
Min. current*	50 mA		
	* typical values dependent on conditions of use		
Switching capacity	Switching capacity		
	AC 15 270 V max. 6 A max. 1250 VA	AC 12 270 V max. 6 A max. 3000 VA	DC 13 110 V max. 6 A max. 110 W
	Rated operating characteristics referred to service category		
	min. voltage*	12 V AC / DC	
	min. current*	50 mA	
	* typical values dependent on conditions of use		
Connection	6-pole flexible lead H05 6 x 0.75 mm ²		
Type of protection	Degree of protection acc. to IEC 60 529 IP66		



Technical Data

Life	
Contact element	10 ⁶ operations
Indicating lamp unit	10 ⁵ output hours
Material	Polyamide
Contact material	
Standard	Silver-nickel
Special	Silver-nickel, gold-plated

Accessories and Spare Parts

Designation	Illustration	Description	Order number	Weight kg
Actuator	 05044E00	for illuminated pushbutton (spring-return)	8602024030	0,019
Colour filter	 05356E00	Colour disk for engaging in the actuator colour:		
		white	8602925580	0,001
		red	8602926580	0,001
		yellow	8602927580	0,001
		green	8602928580	0,001
		blue	8602929580	0,001
Closing part	 05647E00	to close not used mounting holes \varnothing 30.5 mm	8602801587	0,016

Dimensional drawings (all dimensions in mm) – subject to alterations

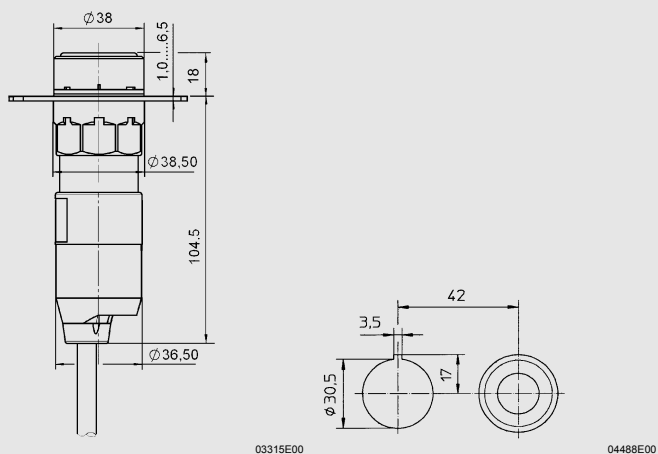

8018 Illuminated pushbutton Cut-out for aligning several devices \varnothing 38 mm in a panel

We reserve the right to make alterations to the technical data, weights, dimensions, designs and products available without notice. The illustrations cannot be considered binding.