

01666E00

## Terminal Boxes Series 8125

- Explosion protection to
  - CENELEC
  - IEC
  - NEC
- For use in
  - Zone 1 and Zone 2
  - Zone 21 and Zone 22
- Fitting with terminals up to max. 300 mm<sup>2</sup>
- Painted sheet steel or stainless steel enclosures
- 6 basic enclosure sizes with various heights
- Degree of protection IP 66

STAHL

Series 8125 terminal boxes are supplied with Phoenix thermoplastic terminals as standard. Terminals from other manufacturers can be fitted. The terminal boxes are fitted to order with terminals and cable entries.

# Zones 1 & 2, 21 & 22

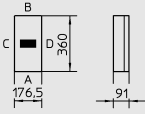
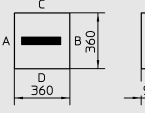
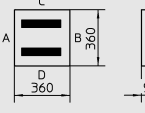
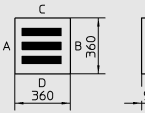
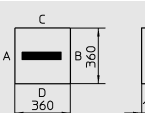
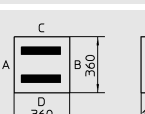
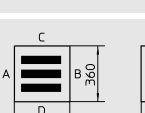

<b>Selection table</b>		for terminal boxes up to max. 35 mm <sup>2</sup>											<b>Ordering code</b>	Weight		
Nominal cross-section [mm <sup>2</sup> ]	Arrangements	Max. number of line-up terminals which can be fitted														
		2.5	4		6		10		16		35					
		UK 3 N	WDU 2,5	MXK4	UK 5 N	WDU 4	UK 6 N	WDU 6	UK 10 N	WDU 10	UK 16 N-Ex	WDU 16	UK 35-Ex	WDU 35		kg
	08849E00	14	-	12	12	-	-	-	-	-	-	-	-	-	<b>8125/ .041- .</b>	1.0
	08848E00	19	19	16	16	16	11	12	9	9	8	-	-	-	<b>8125/ .051- .</b>	1.5
	08847E00	-	-	28	-	-	-	-	-	-	-	-	-	-	<b>8125/ .051- .</b>	1.6
	08846E00	27	28	23	23	24	17	17	13	14	11	-	-	-	<b>8125/ .061- .</b>	2.1
	08845E00	-	-	46	-	-	-	-	-	-	-	-	-	-	<b>8125/ .061- .</b>	2.3
	08844E00	-	-	46	-	-	-	-	-	-	-	-	-	-	<b>8125/ .063- .</b>	3.0
	08843E00	49	51	-	41	42	31	31	24	25	20	-	-	-	<b>8125/ .071- .</b>	3.1
	08842E00	-	-	82	-	-	-	-	-	-	-	-	-	-	<b>8125/ .071- .</b>	3.3
	08841E00	49	51	41	41	42	31	31	24	25	20	20	-	-	<b>8125/ .073- .</b>	4.0
<b>Add. to ordering code:</b>																
Version:		EEx e										<b>8125/1 . . . .</b>				
		EEx i										<b>8125/2 . . . .</b>				
Material:		Sheet steel										<b>8125/ . . . . -1</b>				
		Stainless steel										<b>8125/ . . . . -2</b>				
<b>Note:</b> The ordering codes contain the enclosure with carrier rails and PE or PA rail.																
<b>State with order:</b>		<b>Terminal strips:</b> number and type														
		<b>Cable glands:</b> number, type and side for fitting in enclosure														
		<b>Flanges:</b> Flanges can be fitted to order; please indicate the side on which they are to be fitted.														
Terminal boxes fitted with terminals > 35 mm <sup>2</sup> up to 300 mm <sup>2</sup> on request.																

Selection table		for terminal boxes up to max. 35 mm <sup>2</sup>											Ordering code	Weight	
Nominal cross-section [mm <sup>2</sup> ]	Max. number of line-up terminals which can be fitted											kg			
	2.5	4	6	10	16	35									
Arrangements	UK 3 N	WDU 2,5	MXK4	UK 5 N	WDU 4	UK 6 N	WDU 6	UK 10 N	WDU 10	UK 16 N-Ex	WDU 16	UK 35-Ex	WDU 35		
 08840E00	19	19	-	16	16	11	12	9	9	8	-	-	-	8125/ .071- .	3.1
 08839E00	51	53	-	43	44	32	33	26	26	21	-	-	-	8125/ .081- .	5.5
 08838E00	98	102	82	82	84	62	62	48	50	40	-	-	-	8125/ .081- .	5.7
 08837E00	147	153	123	123	-	-	-	-	-	-	-	-	-	8125/ .081- .	6.0
 08836E00	51	53	43	43	44	32	33	26	26	21	22	17	16	8125/ .083- .	6.5
 08835E00	98	102	82	82	84	62	62	48	50	40	-	-	-	8125/ .083- .	6.7
 08834E00	147	153	123	123	-	-	-	-	-	-	-	-	-	8125/ .083- .	7.0
<b>Add. to ordering code:</b>															
Version:											EEx e	8125/1...-			
											EEx i	8125/2...-			
Material:											Sheet steel	8125/...-1			
											Stainless steel	8125/...-2			
<b>Note:</b>	The ordering codes contain the enclosure with carrier rails and PE or PA rail.														
<b>State with order:</b>	<b>Terminal strips:</b>	number and type													
	<b>Cable glands:</b>	number, type and side for fitting in enclosure													
	<b>Flanges:</b>	Flanges can be fitted to order; please indicate the side on which they are to be fitted.													
Terminal boxes fitted with terminals > 35 mm <sup>2</sup> up to 300 mm <sup>2</sup> on request.															

<b>Selection table</b>		for terminal boxes up to max. 35 mm <sup>2</sup>												<b>Ordering code</b>	Weight
Nominal cross-section [mm <sup>2</sup> ]	Max. number of line-up terminals which can be fitted														
	2.5		4		6		10		16		35		kg		
Arrangements	UK 3 N	WDU 2,5	MXK4	UK 5 N	WDU 4	UK 6 N	WDU 6	UK 10 N	WDU 10	UK 16 N-Ex	WDU 16	UK 35-Ex		WDU 35	
	102	106	86	86	88	64	66	52	52	42	44	-	-	<b>8125/ .093- .</b>	10.0
	196	204	164	164	168	124	124	96	100	80	-	-	-	<b>8125/ .093- .</b>	10.5
	294	306	246	246	-	-	-	-	-	-	-	-	-	<b>8125/ .093- .</b>	11.0
<b>Add. to ordering code:</b>															
Version:												EEx e	<b>8125/1 . . . .</b>		
												EEx i	<b>8125/2 . . . .</b>		
Material:												Sheet steel	<b>8125/ . . . . -1</b>		
												Stainless steel	<b>8125/ . . . . -2</b>		
<b>Note:</b>	The ordering codes contain the enclosure with carrier rails and PE or PA rail.														
<b>State with order:</b>	<b>Terminal strips:</b>	number and type													
	<b>Cable glands:</b>	number, type and side for fitting in enclosure													
	<b>Flanges:</b>	Flanges can be fitted to order; please indicate the side on which they are to be fitted.													
Terminal boxes fitted with terminals > 35 mm <sup>2</sup> up to 300 mm <sup>2</sup> on request.															



Technical Data	
Explosion protection	
Gas explosion protection	⊕ II 2 G EEx edm [ia] IIC T6, T5 or T4
Dust explosion protection	⊕ II 2 D IP66 T80 °C, T95 °C, T130 °C
Certificates	
Gas explosion protection	PTB 00 ATEX 3116
Dust explosion protection	LCIE 03 ATEX 6291
Other certificates	IEXCEX, BKI (Hungary), CSA (Canada), UL (USA), Germanischer Lloyd
Material	
Housing	depending on the version: sheet steel, galvanized, painted, light grey, RAL 7032 or stainless steel 1.4404, electropolished, without painting (painting possible to order)
Gaskets	Polyurethan, foam
Dimensions	see page 8
Flanges	
Standard	the enclosures are supplied without flanges in the standard version
Special	the enclosures can be fitted on one or more sides with flanges; flange material: sheet steel, galvanized or stainless steel
Cover fixing	
Standard	M 6, cheese-head screws with combined slot; captive, stainless steel
Special	with cover hinges
Rated working voltage	max. 1100 V, AC/DC (depending on terminals fitted)
Degree of protection	IP 66
Ambient temperature	- 20 °C ... + 40 °C (T6) with cable glands 8161 - 20 °C ... + 55 °C (T5) with cable glands 8161 - 20 °C ... + 40 °C (T6) with metal glands (depending on gasket) - 20 °C ... + 55 °C (T5) with metal glands (depending on gasket)
Terminals	Max. nominal cross-section 300 mm <sup>2</sup>



### Cable gland Table for max. number of entries possible with cable glands 8161

Attention:





The maximum number of cable entries which can be mounted in the enclosure walls depends on the position of the components installed.

Gland	Enclosure size																							
 Size	8125/.041				8125/.051				8125/.061				8125/.063											
	without flanges		with flanges		without flanges		with flanges		without flanges		with flanges		without flanges		with flanges									
	A	B	C	D	A/B	C/D	A	B	C	D	A/B	C/D	A	B	C	D	A/B	C/D						
M 16 x 1.5	9	10	16	15	--	4	15	16	15	4	4	15	16	22	21	4	4	26	27	37	36	16	16	
M 20 x 1.5	3	4	7	7	--	3	7	7	7	3	3	7	7	11	11	3	3	17	17	23	23	8	8	
M 25 x 1.5	2	2	5	5	--	3	5	5	5	3	3	5	5	9	8	3	3	12	12	18	17	6	6	
M 32 x 1.5	1	2	3	3	--	2	3	3	3	2	2	3	3	4	4	2	2	7	7	10	10	4	4	
M 40 x 1.5	1	1	2	2	--	2	2	2	2	--	--	2	2	3	3	--	--	5	5	8	7	2	2	
M 50 x 1.5	1	1	2	2	--	2	2	2	2	--	--	2	2	3	2	--	--	3	3	5	5	1	1	
M 63 x 1.5	--	--	--	--	--	--	--	--	--	--	--	--	--	--	--	--	--	2	2	3	3	1	1	

## Cable gland Table for max. number of entries possible with cable glands 8161

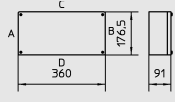
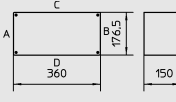
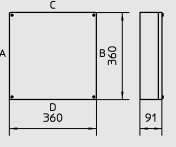
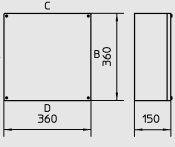

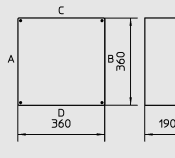
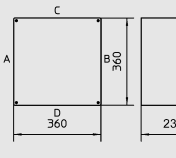
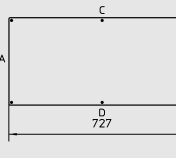
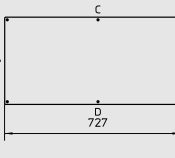

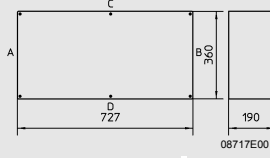

Attention:

The maximum number of cable entries which can be mounted in the enclosure walls depends on the position of the components installed.

Gland	Enclosure size																							
	8125/.071				8125/.073				8125/.081				8125/.083											
																								
	08225E00				08714E00				08224E00				08715E00											
Size	without flanges		with flanges		without flanges		with flanges		without flanges		with flanges		without flanges		with flanges									
	A	B	C	D	A/B	C/D	A	B	C	D	A/B	C/D	A	B	C	D	A/B	C/D						
M 16 x 1.5	15	16	34	33	4	8	26	27	57	56	16	31	33	34	34	33	8	8	58	58	57	56	31	31
M 20 x 1.5	7	7	18	18	3	6	17	17	39	38	8	19	18	18	18	18	6	6	38	38	38	38	19	19
M 25 x 1.5	5	5	14	14	3	6	12	12	30	29	6	16	15	15	14	14	6	6	30	30	30	29	16	16
M 32 x 1.5	3	3	7	7	2	4	7	7	16	16	4	9	7	7	7	7	4	4	17	17	16	16	9	9
M 40 x 1.5	2	2	6	5	--	--	5	5	11	11	2	5	5	6	6	5	--	--	11	11	11	11	5	5
M 50 x 1.5	2	2	5	4	--	--	3	3	9	9	1	4	4	4	5	4	--	--	9	9	9	9	4	4
M 63 x 1.5	--	--	--	--	--	--	2	2	4	4	1	2	--	--	--	--	--	--	4	4	4	4	2	2
	8125/.085				8125/.086				8125/.091				8125/.093											
																								
	08716E00				06519E00				04435E00				08223E00											
Size	without flanges		with flanges		without flanges		with flanges		without flanges		with flanges		without flanges		with flanges									
	A	B	C	D	A/B	C/D	A	B	C	D	A/B	C/D	A	B	C	D	A/B	C/D						
M 16 x 1.5	80	80	82	81	53	53	106	106	106	105	53	53	33	34	73	72	8	16	58	58	122	122	31	62
M 20 x 1.5	47	47	47	46	26	26	66	66	66	65	26	26	18	18	38	38	6	12	38	38	77	77	19	38
M 25 x 1.5	37	37	37	37	20	20	52	52	52	52	20	20	15	15	31	31	6	12	30	30	63	63	16	32
M 32 x 1.5	22	22	22	22	12	12	29	29	29	29	12	12	7	7	16	16	4	8	17	17	41	41	9	18
M 40 x 1.5	16	16	16	16	8	8	18	18	18	18	8	8	5	6	12	12	--	--	11	11	24	24	5	10
M 50 x 1.5	9	9	9	9	5	5	15	15	15	15	5	5	4	4	10	9	--	--	9	9	19	19	4	8
M 63 x 1.5	7	8	8	7	3	3	8	8	8	8	3	3	--	--	--	--	--	--	4	4	10	10	2	4
	8125/.095																							
																								
	08717E00																							
Size	without flanges		with flanges																					
	A	B	C	D	A/B	C/D																		
M 16 x 1.5	80	80	171	170	53	106																		
M 20 x 1.5	47	47	151	114	26	52																		
M 25 x 1.5	37	37	82	81	20	40																		
M 32 x 1.5	22	22	50	49	12	24																		
M 40 x 1.5	16	16	29	29	8	16																		
M 50 x 1.5	9	9	21	21	5	10																		
M 63 x 1.5	7	8	16	16	3	6																		



## Accessories and spare parts

Designation	Illustration	Description	Ordering code	Weight kg
Flange	 05740E00	Size 1 sheet steel	<b>8125001490</b>	0,200
		Size 1 stainless steel	<b>8125902490</b>	0,340
		can be mounted on enclosure side		
		8125/.051 C/D		
		8125/.061 A/B/C/D		
		8125/.071 A/B/C/D		
	 05738E00	Size 2 sheet steel	<b>8125002490</b>	1,050
		Size 2 stainless steel	<b>8125904490</b>	1,310
		can be mounted on enclosure side		
		8125/.073 C/D		
		8125/.083; /.085 A/B/C/D		
		8125/.093; /.095 A/B/C/D		
	 05739E00	Size 3 sheet steel	<b>8125003490</b>	1,050
		Size 3 stainless steel	<b>8125906490</b>	0,630
		can be mounted on enclosure side		
		8125/.063 A/B/C/D		
8125/.073 A/B				
 08744E00	Size 4 sheet steel	<b>8125004490</b>	2,160	
	Size 4 stainless steel	<b>8125908490</b>	2,146	
	can be mounted on enclosure side			
	8125/.085 A/B/C/D			
	8125/.095 A/B/C/D			
Sealing frames	 04901E00	Size 0 (68 mm x 68 mm)	<b>8146003100</b>	0,010
		Size 1 (68 mm x 128 mm)	<b>8146001100</b>	0,020
		Size 2 (126 mm x 266 mm)	<b>8146004100</b>	0,040
		Size 3 (126 mm x 126 mm)	<b>8146011100</b>	0,100
		Size 4 (352 mm x 155 mm)	<b>8125004100</b>	0,160
Lid hinges	 05737E00	8125 for retrofitting to enclosure Kit consisting of:		
		2 hinges	<b>8125802290</b>	0,034
		3 hinges	<b>8125803290</b>	0,051

Dimension drawings (all dimensions in mm) - subject to alterations

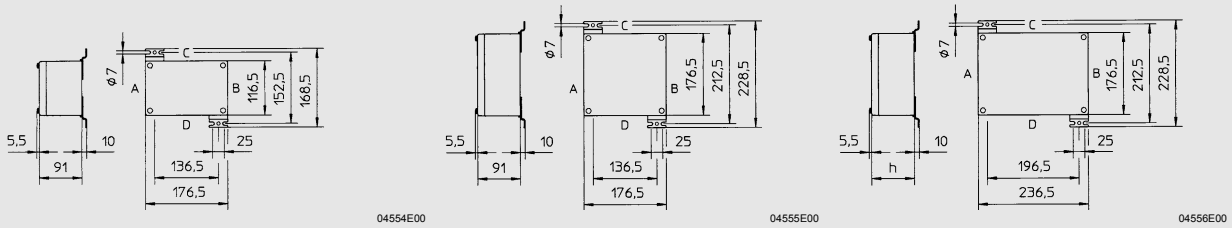

8125/04.

8125/05.

8125/06.

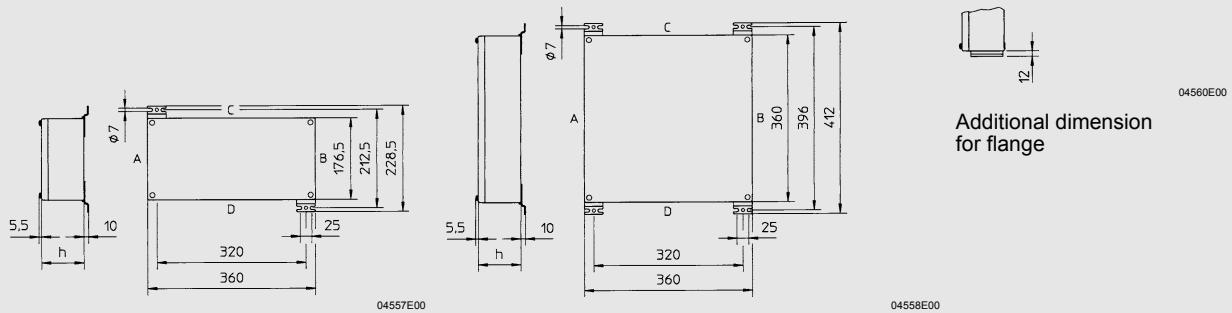

8125/07.

8125/08.

Additional dimension  
for flange

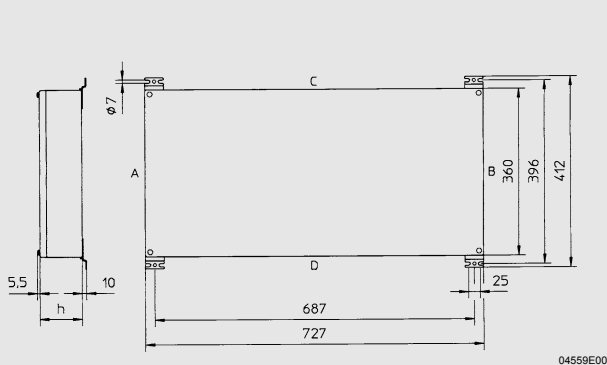

8125/09.

Enclosure	Hight of enclosure h			
	8125/...1 91 mm	8125/...3 150 mm	8125/...5 190 mm	8125/...6 230 mm
8125/04.	X	-	-	-
8125/05.	X	-	-	-
8125/06	X	X	-	-
8125/07.	X	X	-	-
8125/08.	X	X	X	X
8125/09.	X	X	X	-

X ... can be supplied

We reserve the right to make alterations to the technical data, weights, dimensions, designs and products available without notice. The illustrations cannot be considered binding.

