



01859E00

Fire Alarm Station Series 8146/5052

- Explosion protection to
 - CENELEC
 - IEC
- Can be used in Zone 1 and Zone 2
- Colour red (RAL 3000)
- Enclosure in polyester resin
- 3 alternatives available
 - Alarm station 8146/5052-C796
Mushroom stay-put button with manual contact. Continuous alarm by pressing automatically locking alarm button
 - Alarm station 8146/5052-C797
Mushroom stay-put key release with manual contact. Continuous alarm by pressing automatically locking alarm button
 - Alarm station 8146/5052-C814
Automatic contact as alarm button springs out when glass window broken. An 8208 resistance module can be retro-fitted to protect against short-circuit and monitor for open-circuit



Selection table







Version	Schematic	Ordering code	Weight kg
Manual contact	with mushroom stay-put button 	8146/5052-C796	2,270
	with mushroom button with key lock 	8146/5052-C797	2,270
Automatic contact	with mushroom button 	8146/5052-C814	2,270

Zones 1 & 2

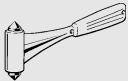
Technical Data

Explosion protection	⊕ II 2 G EEx de IIC T6
Certificates	PTB 01 ATEX 1105
Version	Acc. to DIN 14 678 (non-automatic alarm station K)
Enclosure	Polyester resin, glass fibre reinforced, red, RAL 3000
Cover fixing	Triangular head screws, captive, stainless steel, thread M 6, spanner M 4
Rated operational voltage U_e	500 V AC 240 V DC
Rated working current I_e	$I_{th2} = 6$ A, AC; 1 A, 60 V, DC; L/R = 100 ms
Switching capacity	see contact block 8082
Contacts	1 NC + 1 NO
Degree of protection	IP 66, even after damaging window
Ambient temperature	- 50 °C ... + 60 °C
Flexible lead	2,5 mm ² flexible
Cable glands	1 x M 25 from below, outer diameter 7 mm ... 17 mm; 1 x M 25 stopping plug from below
Resistor module	Complete retrofit kit in control unit 8208 with integral resistors for open-circuit monitoring and short-circuit protection. Resistance values as order (adapted to signalling system)

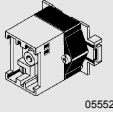
Accessories and spare parts

Designation	Illustration	Description	Ordering code	Weight kg
Emergency hammer	 08983E00		9526010	0,070
Window	 05551E00	for 8146/5052-C...	8603905580	0,034
Key	 05026E00	for 8146/5052-C797	3746020	0,014
Label	 05124E00	Text „Fire service“ acc. to nach DIN 14 678	8146906852	0,001
Resistor module	 05552E00	Retrofit in control unit 8208 2 integral resistors to order; e.g. 3,3 kΩ open-circuit monitoring 4,7 kΩ short-circuit protection	8800001406	0,100
Triangular socket	 05262E00	for thread M 4	8198001400	0,044



Dimension drawings (all dimensions in mm) - subject to alterations

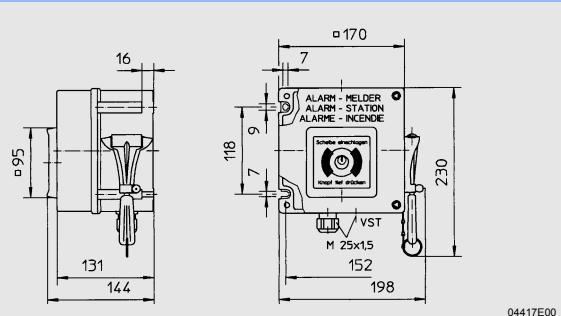

We reserve the right to make alterations to the technical data, weights, dimensions, designs and products available without notice. The illustrations cannot be considered binding.

8146/5052-C796, -C797 and -C814 Alarm stations