



01846E00

Ammeter / Voltmeter Series 8402, 8403, 8405, 8404

- Explosion protection to
 - CENELEC
 - IEC
- For use in Zone 1 and Zone 2
- Fast comparison of measured with set values
- Versions available
 - Ammeter
Series 8405,
Series 8403 and
Series 8402
 - Voltmeter Series 8404

STAHL





The ammeter and voltmeters are moving iron instruments with an accuracy class 2,5.

The externally adjustable red pointer of the ammeter enables quick comparison of measured with set values.

On ammeter for 1 A and 5 A CT connection a scale can be slid in from the side, thus enabling simple and quick local alignment.

Zones 1 & 2



Selection table					
Version	Description	Measuring range	Overload scale	Ordering code	Weight kg
 Ammeter Ex i Series 8402 □ 64 mm	direct measuring	0 mA ... 20 mA resp. 4 mA ... 20 mA for connection to certified intrinsically-safe circuits only	--	8402/5	0,222
		02414E00			
 Ammeter Series 8403 □ 72 mm	direct measuring	0 mA ... 20 mA / 40 mA	2 times	8403/2-0,02/0,04	0,218
		4 mA ... 20 mA / 40 mA	2 times	8403/2-100%/200%	0,218
		0 A ... 1 A / 2 A	2 times	8403/2-1/2	0,216
		0 A ... 4 A / 8 A	2 times	8403/2-4/8	0,222
		0 A ... 10 A / 20 A	2 times	8403/2-10/20	0,222
		0 A ... 15 A / 30 A	2 times	8403/2-15/30	0,222
		0 A ... 25 A / 50 A	2 times	8403/2-25/50	0,264
	for CT (slide-in scale)	sek. 1 A	2 or 5 times	8403/2-1	0,216
sek. 5 A	2 or 5 times	8403/2-5	0,216		
 Ammeter Series 8405 □ 64 mm	direct measuring	0 mA ... 20 mA / 40 mA	2 times	8405/2-0,02/0,04	0,122
		4 mA ... 20 mA / 40 mA	2 times	8405/2-0,02/0,04	0,122
		0 A ... 1 A / 2 A	2 times	8405/2-1/2	0,124
		0 A ... 4 A / 8 A	2 times	8405/2-4/8	0,118
		0 A ... 10 A / 20 A	2 times	8405/2-10/20	0,120
		0 A ... 15 A / 30 A	2 times	8405/2-15/30	0,122
	for CT (plain scale)	1 A	2 or 5 times	8405/2-1	0,125
		5 A	2 or 5 times	8405/2-5	0,125
 Voltmeter Series 8404 □ 72 mm	direct measuring	0 V ... 10 V	--	8404/2-10	0,216
		0 V ... 100 V	--	8404/2-100	0,216
		0 V ... 150 V	--	8404/2-150	0,216
		0 V ... 250 V	--	8404/2-250	0,274
		0 V ... 500 V	--	8404/2-500	0,216
 Bezel	Bezel □ 64 mm (for ammeter Series 8405)	--	--	8603801587	0,500
		Bezel □ 72 mm (for ammeter Series 8403 and voltmeter Series 8404)	--	--	8603802587
Note	Other measuring ranges or scales on request				

Technical Data				
Version	Ammeter EEx i Series 8402	Ammeter Series 8403	Ammeter Series 8405	Voltmeter Series 8404
Explosion protection	⊕ II 2 G EEx e II T6	⊕ II 2 G EEx e II T6	⊕ II 2 G EEx e II T6	⊕ II 2 G EEx e II T6
Certificates	PTB 98 ATEX 2101	PTB 01 ATEX 2158 U	PTB 01 ATEX 2158 U	PTB 01 ATEX 2158 U
Other certificates	--	IECEX	IECEX	IECEX
Housing	Polyester	Polyamide - Polyester	Polyamide - Polyester	Polyamide - Polyester
Isolating voltage	--	690 V	690 V	690 V
Current	--	AC 15 Hz ... 100 Hz, DC available	AC 15 Hz ... 100 Hz, DC available	AC 15 Hz ... 100 Hz, DC available
Movement	Moving coil	Moving iron	Moving iron	Moving iron
Accuracy	Class 1.5	Class 2,5	Class 2,5	Class 2,5
Scale	0 - 100 linear, Quadrant scale, Length 63 mm	Quadrant scale Length 63 mm	Quadrant scale Length 40 mm	Quadrant scale Length 63 mm
Overload capacity		2 x I _N 25 sec 50 x I _N 1 sec referred to full scale value of the range	2 x I _N 25 sec 50 x I _N 1 sec referred to full scale value of the range	1,2 times continuous 2 times 60 sec
Mounting	on mounting rail TS35	on rail TS 35	on rail TS 35	on rail TS 35
Power consumption	--	max. 0,43 W	max. 0,43 W	max. 2,1 VA
Max. short circuit current	150 mA	--	--	--
Internal resistance	2.93 Ω	--	--	--
Internal inductance	68.5 μH	--	--	--
Internal capacitance	~ 0	--	--	--
Ambient temperature	- 20 °C ... + 40 °C	- 20 °C ... + 40 °C	- 20 °C ... + 40 °C	- 20 °C ... + 40 °C
Flexible lead	2,5 mm ² flexible 4 mm ² solid	2,5 mm ² flexible 4 mm ² solid	2,5 mm ² flexible 4 mm ² solid	2,5 mm ² flexible 4 mm ² solid
Calotte				
Material	Glass - polyester	Glass - polyester	Glass - polyester	Glass - polyester
Degree of protection	IP 66	IP 66	IP 66	IP 66
Gasket	Neoprene	Neoprene	Neoprene	Neoprene
Impact strenght	≥ 7 Nm	≥ 7 Nm	≥ 7 Nm	≥ 7 Nm
Sizes	□ 72 mm	□ 72 mm	□ 64 mm	□ 72 mm

STAHL

Accessories and spare parts

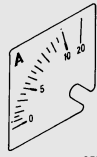
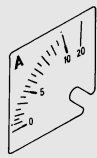
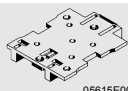
Designation	Illustration	Description	Ordering code	Weight kg
Slide-in scale for Series 8405 and Series 8403		for Series 8405 and Series 8403 Measuring range - overload 2 times 0 A ... 1 A 5 A 10 A 15 A 20 A 25 A 30 A 40 A 50 A 60 A 75 A 100 A 150 A 200 A 300 A 500 A	State measuring range	
		for Series 8405 and Series 8403 Measuring range - overload 5 times 0 A ... 1 A 5 A 10 A 15 A 20 A 25 A 30 A 40 A 50 A 60 A 75 A 100 A 150 A 200 A 250 A 300 A 500 A	State measuring range	
Mounting plate		for Series 8405 snap on rail TS 35	8040805290	0,022

Dimension drawings (all dimensions in mm) - subject to alterations

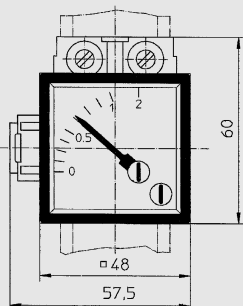
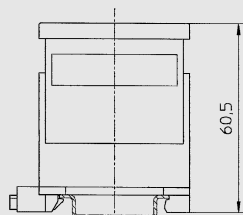

04071E00

Ammeter Series 8405

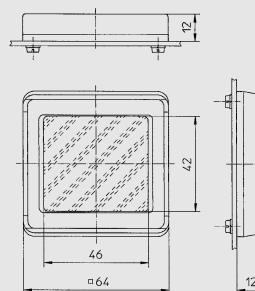

04087E00

**Bezel assembly code 740
for ammeter Series 8405**

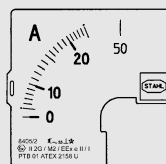

04490E00

Slide-in scale for ammeter Series 8405 with CT

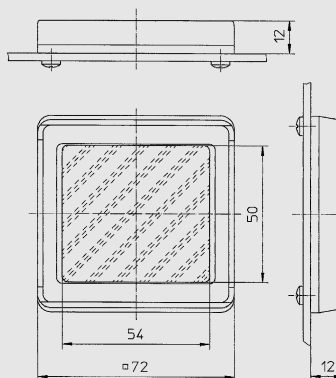
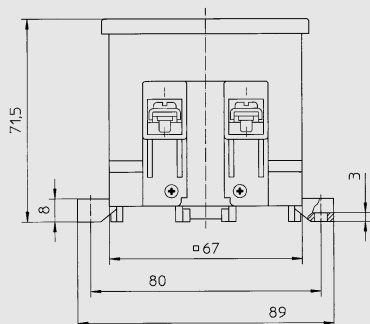

03348E00

**Bezel assembly code 145
for ammeter Series 8403 and
voltmeter Series 8404**

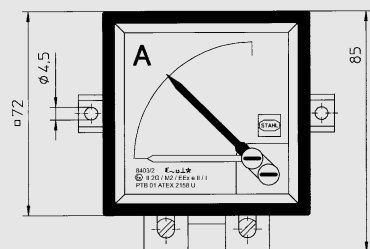

04576E00

Ammeter Series 8403

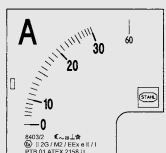

04492E00

Slide-in scale for ammeter Series 8403 with CT



